



BELL 40

wiring system

Bell 40 is the largest pendant luminaire in the family. Its sleek design and matt black finish make it ideal for large spaces that need efficient LED lighting and minimalist styling. For more advanced lighting control, select the DALI or CASAMBI dimming option on the canopy when ordering.

*You can customise the finish by contacting us.

Qualities

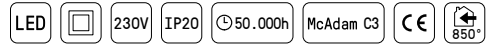

Led Colour



Regulation



Beam Angle



Finish



Diffuser



Installation



TEC. DRAWINGS

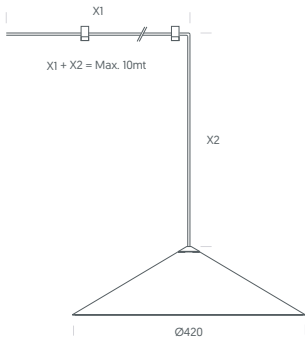

	W	mA	TEMP	LUM	CRI
BELL 40	4.2W	500mA	2.700K	505	>90
			3.000K	535	

REF. CODE

CODE BASE Technology Power LED Control LED Colour Beam angle Installation Finishes

WSBG + A Led + 03 Ø420/4.5W + X NoDriver + 2 2700K + 9 >90° + P Pendant + BS Black

3 3000K

ACCESSORIES



TENSOR*
BSTN



CANOPY

WSFLA20_XXSBS - Máx. 4 luminarias
 WSFLA40_XXSBS - Máx. 8 luminarias
 WSFLA60_XXSBS - Máx. 12 luminarias

*Each luminaire includes 2 units.

