

LINE R PROFILES

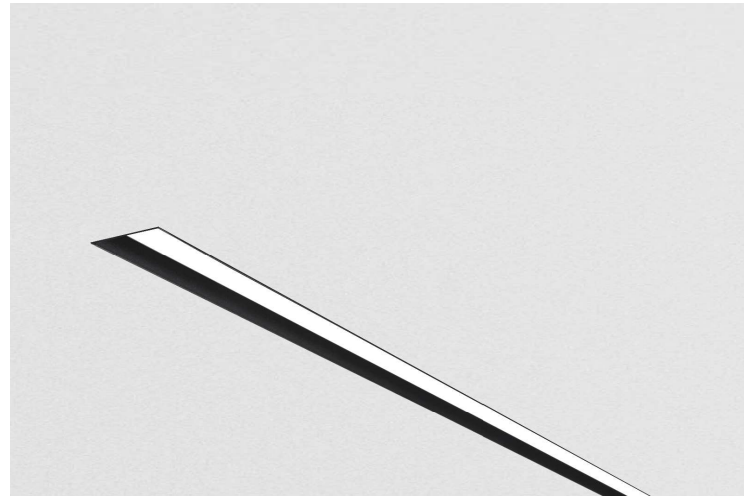

	W	mm	mA	TEMP	LUM	CRI
LINE_07	15	705	500	3.000K	2.325	>90
				4.000K	2.499	
LINE_11	23	1.125	500	3.000K	3.720	>90
				4.000K	3.999	
LINE_14	30	1.405	500	3.000K	4.650	>90
				4.000K	4.998	
LINE_18	38	1.825	500	3.000K	6.045	>90
				4.000K	6.498	
LINE_22	47	2.245	500	3.000K	7.440	>90
				4.000K	7.998	
LINE_28	59	2.810	500	3.000K	9.300	>90
				4.000K	9.997	

Para medidas mas largas de 2810 mm, utilizar combinaciones de perfiles.
For longer measurements of 2245 mm You have to use combination of differents profiles.

IMPORTANTE: Una alimentación para máximo 10 metros. / **ATTENTION:** Maximum 10 meters per one power supply.

TEC.DRAWINGS

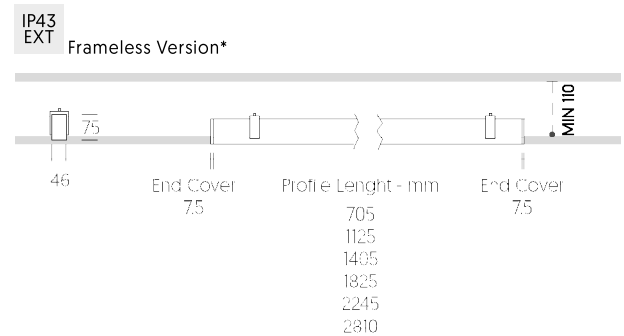
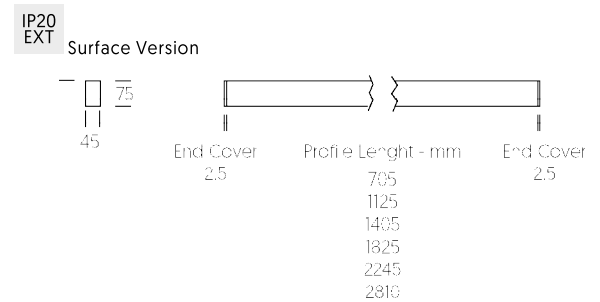
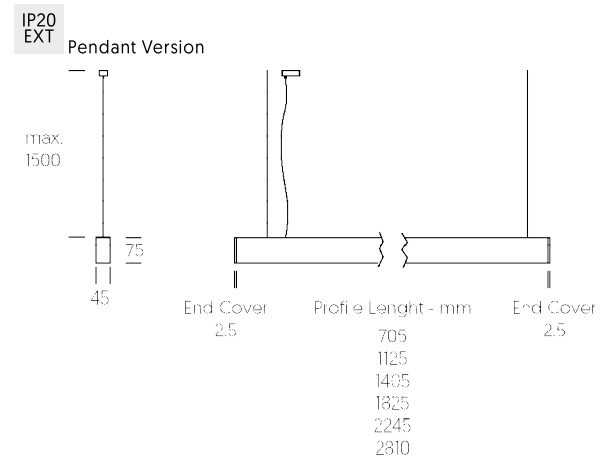



TECHNICAL DETAILS

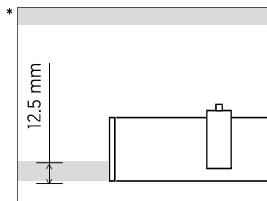

Para techos de 12.5 mm/
Ceiling thickness 12.5 mm

LED	⊕	230V	IP20	⌚ 60,000h L80	McAdam C3
≈ 14W	> 2,000lm	LNER A 07	• •	9	• •
≈ 22W	> 3,000lm	LNER A 11	• •	9	• •
≈ 28W	> 4,000lm	LNER A 14	• •	9	• •
≈ 36W	> 6,000lm	LNER A 18	• •	9	• •
≈ 45W	> 7,000lm	LNER A 22	• •	9	• •
≈ 56W	> 9,000lm	LNER A 28	• •	9	• •

BASIC OPTIONS

NO DIM	N	No Dimmable							
3K	3	3000K							
9	9	120°							
A	A	Ice Difusser							
WS	WS	Satin White	LNER	A	••	N	3	9	A WS
BS	BS	Satin Black	LNER	A	••	N	3	9	A BS

CUSTOMIZE OPTIONS

LED CONTROL

PUSH	F	Dimmable Push	LNER	A	••	F	•	9	• •
DALI	D	Dimmable Dali	LNER	A	••	D	•	9	• •

LED COLOR TEMPERATURE

4K	4	4000K	LNER	A	••	•	4	9	• •
-----------	----------	-------	------	---	----	---	----------	----------	-----

COMPLEMENTS CODES

PENDANT VERSION

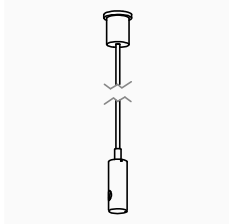

Kit Suspension

1.5Meters LNEXKSUP150SS
*5Meters LNEXKSUP500SS

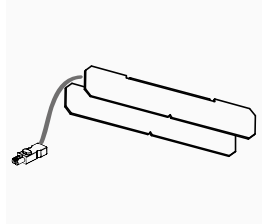

Interior Joint NO-DIM

1.5Meters LNXX XXXX ELUN1
2.0Meters LNXX XXXX ELUN2

Interior Joint DIM

1.5Meters LNXX XXXX ELUD1
2.0Meters LNXX XXXX ELUD2

1,5Metros estandar - Standar 1,5 Meters
*5Metros opcional - Optional 5 Meters

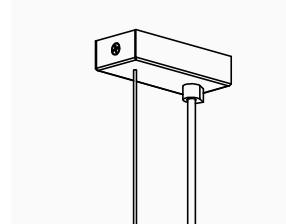

Electrical Susp. DIM

1.5Meters LNEXKSED150BS Black
1.5Meters LNEXKSED150WS White
*5Meters LNEXKSED500BS Black
*5Meters LNEXKSED500WS White

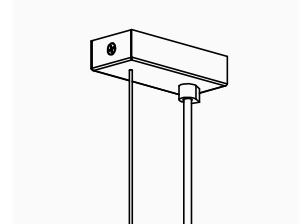

Electrical Susp. NO-DIM

1.5Meters LNEXKSEN150BS Black
1.5Meters LNEXKSEN150WS White
*5Meters LNEXKSEN500BS Black
*5Meters LNEXKSEN500WS White

SINGLE VERSION

Line 07 - 14 - 18 - 22 - 28

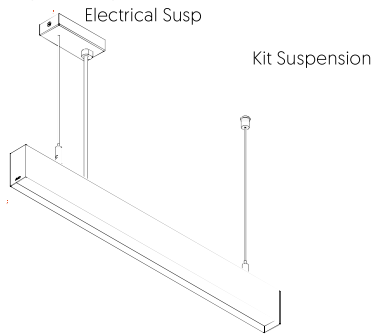

CONTINUOUS VERSION

Line 32 - 37 - 42 - 46 - 50 - 56

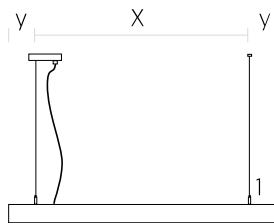
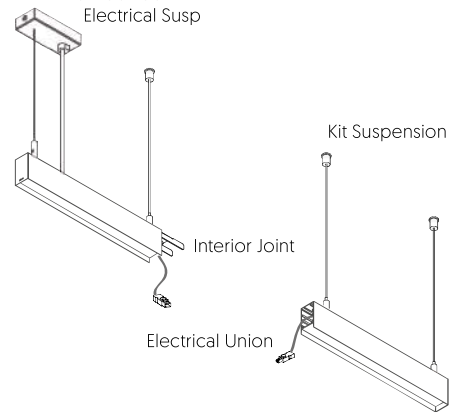

Line 07-11-14-18-22

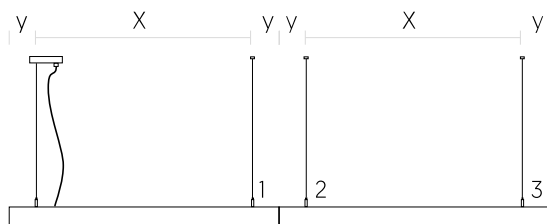

Line 32-37-42-46-50-66

GUÍA COMPLEMENTOS/ COMPLEMENTS GUIDE

Ref.		Lenght	Elect Susp	Kit Susp.	Ele.Union	X	Y
Line 07	07	705 mm	1	1	-	605	50
Line 11	11	1.125 mm	1	1	-	1025	50
Line 14	14	1.405 mm	1	1	-	1.305	50
Line 18	18	1.825 mm	1	1	-	1.725	50
Line 22	22	2.245 mm	1	1	-	2.125	50
Line 28	28	2.810 mm	1	1	-	2.710	50
Line 32	14+18	3.230 mm	1	3	1.5m		50
Line 37	18+18	3.650 mm	1	3	2m		50
Line 42	28+14	4.215 mm	1	3	1.5m		50
Line 46	28+18	4.635 mm	1	3	1.5m		50
Line 50	28+22	5.055 mm	1	3	1.5m		50
Line 56	28+28	5.620 mm	1	3	1.5m		50

COMPLEMENTS CODES

FRAMELESS VERSION

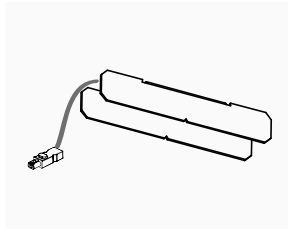

Interior Joint NO-DIM
1.5Meters LNXX XXXX ELUN1
2.0Meters LNXX XXXX ELUN2

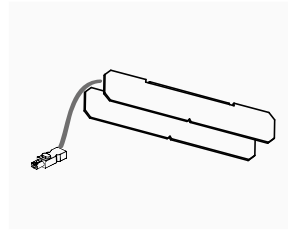

Interior Joint DIM
1.5Meters LNXX XXXX ELUD1
2.0Meters LNXX XXXX ELUD2

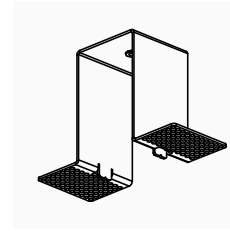

Ceiling Bracket Line R

SINGLE VERSION

Line 07 - 14 - 18 - 22 - 28

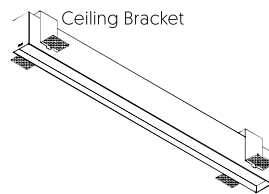

Ceiling Bracket

CONTINUOUS VERSION

Line 32 - 37 - 42- 46 - 50 - 56

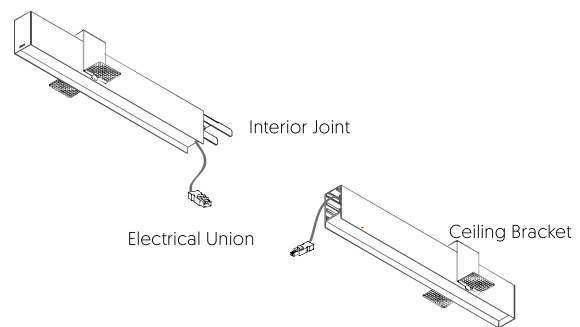

Interior Joint

Electrical Union

Ceiling Bracket

GUÍA COMPLEMENTOS/ COMPLEMENTS GUIDE

Ref.		Lenght (L)		Bracket	Int. Joint	Ele. Union
Line 07	{07}	710 mm	[L+10]x47	2	-	-
Line 11	{11}	1.135 mm	[L+10]x47	2	-	-
Line 14	{14}	1.415 mm	[L+10]x47	2	-	-
Line 18	{18}	1.835 mm	[L+10]x47	2	-	-
Line 22	{22}	2.255 mm	[L+10]x47	3	-	-
Line 28	{28}	2820 mm	[L+10]x47	3	-	-
Line 32	{14+18}	3.240 mm	[L+10]x47	4	1	1.5m
Line 37	{18+18}	3.660 mm	[L+10]x47	4	1	2m
Line 42	{28+14}	4.225 mm	[L+10]x47	6	1	1.5m
Line 46	{28+18}	4.645 mm	[L+10]x47	6	1	1.5m
Line 50	{28+22}	5.065 mm	[L+10]x47	7	1	1.5m
Line 56	{28+28}	5.630 mm	[L+10]x47	8	1	1.5m

COMPLEMENTS CODES

SURFACE VERSION

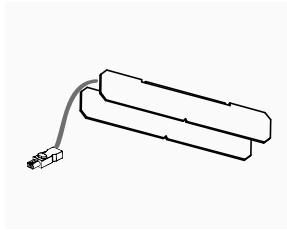

Interior Joint NO-DIM
1.5Meters LNXX XXXX ELUN1
2.0Meters LNXX XXXX ELUN2

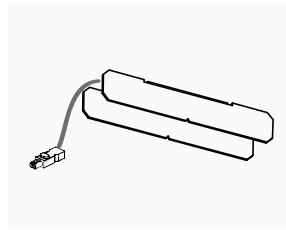

Interior Joint DIM
1.5Meters LNXX XXXX ELUD1
2.0Meters LNXX XXXX ELUD2

SINGLE VERSION

Line 07 - 14 - 18 - 22 - 28

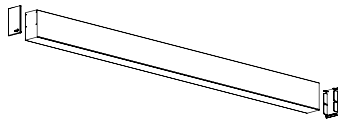

CONTINUOUS VERSION

Line 32 - 37 - 42 - 46 - 50 - 56

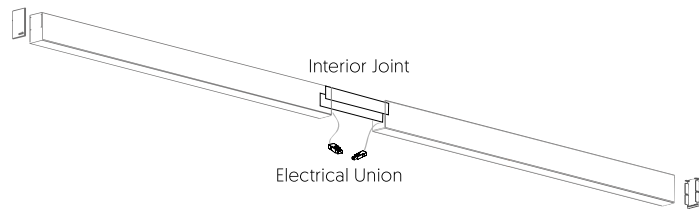

GUÍA COMPLEMENTOS/ COMPLEMENTS GUIDE

Ref.		Lenght (L)	Ele. Union
Line 07	{07}	710 mm	-
Line 11	{11}	1.135 mm	-
Line 14	{14}	1.415 mm	-
Line 18	{18}	1.835 mm	-
Line 22	{22}	2.255 mm	-
Line 28	{28}	2820 mm	-
Line 32	{14+18}	3.240 mm	1.5m
Line 37	{18+18}	3.660 mm	2m
Line 42	{28+14}	4.225 mm	1.5m
Line 46	{28+18}	4.645 mm	1.5m
Line 50	{28+22}	5.065 mm	1.5m
Line 56	{28+28}	5.630 mm	1.5m