

We have categorized our LED strips to facilitate selection according to their specific application, ensuring that our customers find the perfect solution for every lighting need. By following these criteria, we ensure that each application has the appropriate LED strip, guaranteeing optimal performance and customer satisfaction.

Color Uniformity (MacAdam Steps)

We have chosen LED strips with a low number of MacAdam steps. This ensures that our strips offer excellent color uniformity, essential for applications where light consistency is crucial.

LED Quantity per Meter

We select strips with a high density of LEDs per meter. This guarantees continuous and uniform lighting, reducing shadows and dark spots.

Color Temperature

We offer LED strips in various color temperatures: Warm White (2700K), Neutral White (3000K), Cool White (4000K), RGB, RGB+W, and Tunable White.

Protection Index (IP)

Our LED strips are available in various protection levels: IP20 for indoor use and IP65/IP67 for outdoor areas.

Power and Efficiency

We have selected LED strips with high energy efficiency, allowing our customers to choose the right light intensity for each application while maintaining low energy consumption.

Hemos categorizado nuestras tiras LED para facilitar la selección según su aplicación específica, al poder asegurar que nuestros clientes encuentran la solución perfecta para cada necesidad de iluminación. Al seguir estos criterios, aseguramos que cada aplicación cuente con la tira LED adecuada, garantizando un rendimiento óptimo y la satisfacción de nuestros clientes.

Uniformidad del Color (MacAdam Steps)

Hemos elegido tiras LED con un bajo número de pasos MacAdam. Esto asegura que nuestras tiras ofrezcan una uniformidad de color excelente, esencial para aplicaciones donde la consistencia de la luz es crucial.

Cantidad de LEDs por Metro

Seleccionamos tiras con una alta densidad de LEDs por metro. Esto garantiza una iluminación continua y uniforme, reduciendo sombras y puntos oscuros.

Temperatura de Color

Ofrecemos tiras LED en varias temperaturas de color: Blanco cálido (2700K), Blanco neutro (3000K), Blanco frío (4000K), RGB, RGB+W y Tunable White.

Índice de Protección (IP)

Nuestras tiras LED están disponibles en varios niveles de protección: IP20 para uso interior y IP65/IP67 para áreas exteriores.







Potencia y Eficiencia

Hemos seleccionado tiras LED con una alta eficiencia energética, esto permite a nuestros clientes elegir la intensidad de luz adecuada para cada aplicación, manteniendo al mismo tiempo un bajo consumo de energía.

quick guide

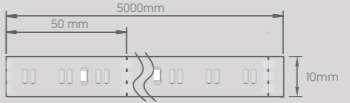
guía rápida

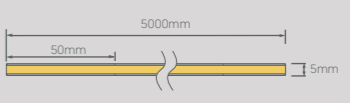
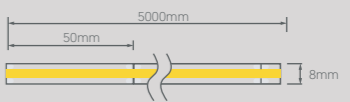
POWER	VOLTAGE	TEMP.	CRI	LED/m	EFFICIENCY
4.8W	24V	2.7K 3K 4K	>90	128	>760lm/m
14.4W	24V	2.7K 3K 4K	>90	160	>1416lm/m
18W	24V	2.7K 3K 4K	>90	128	>2890lm/m
28.8W	24V		>90	240	>1043lm/m
14.4W	24V		-	120	450lm/m
19W	24V		>90	60	>850lm/m
14.4W	24V		>90	60	718lm/m
7W	24V	2.7K 3K 4K	>90	480	>420lm/m
10W	24V	2.7K 3K 4K	>90	480	>830lm/m
10W	24V	2.7K 3K 4K  	>90	120	>350lm/m
10W	24V	2.7K 3K 4K	>90	120	>570lm/m

PCB WIDTH	UNIT CUT	IP	TECHNICAL DRAWING
10 - 12 mm	62.5 mm	20 - 65	
8 - 11 mm	50 mm	20 - 65	
10 mm	62.5 mm	20	
10 mm	50 mm	20	
10 mm	100 mm	20	
10 mm	100 mm	20	
10 mm	100 mm	20	
5 mm	50 mm	20	
8 mm	50 mm	20	
06x10 mm	62.5 mm	67	
10x10 mm	35.7 mm	67	

single-color

monocolor

4.8W

Qualities



Led Colour



Regulation



Beam Angle

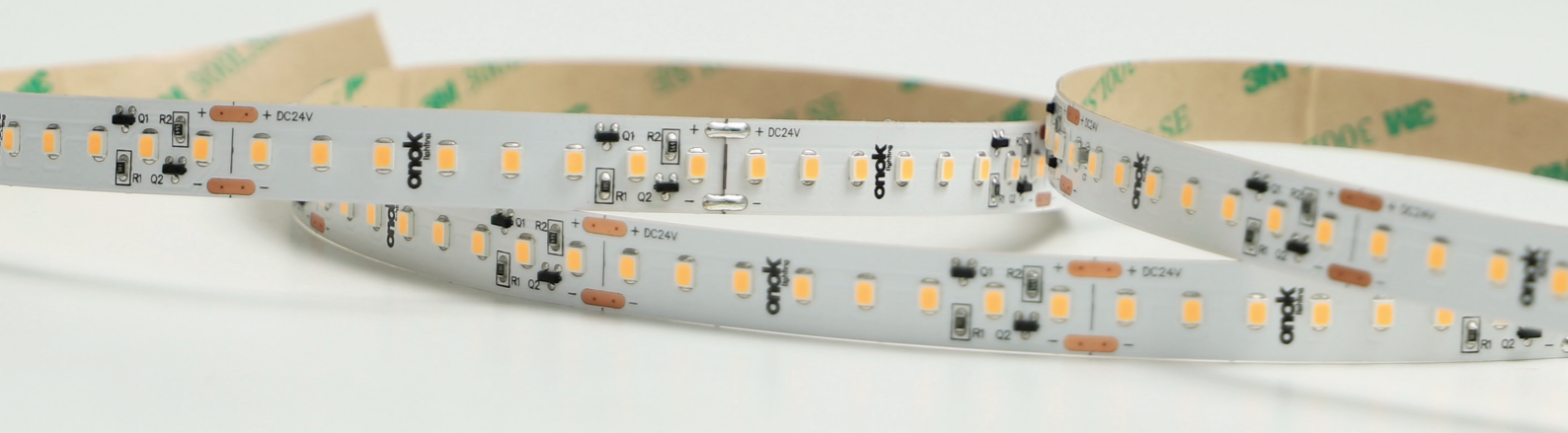

High efficiency constant current circuit design to realize 160lm/w led strip achieving real green, energy saving and environmental protection. The High Efficiency SMD2835 LED strip light product line is an ideal solution for commercial applications needing maximum brightness to highlight features.

TECHNICAL DATA

	CODE	W	VOLTAGE	TEMP	LUM/m	CRI	PUBLIC PRICE / meter
Tira LED 4.8W	TL05A05N29X20			2.700K			12.58 €
	TL05A05N39X20	4.8	24V	3.000K	>760lm	>90	12.58€
	TL05A05N49X20			4.000K			12.58€

TEC. DRAWINGS

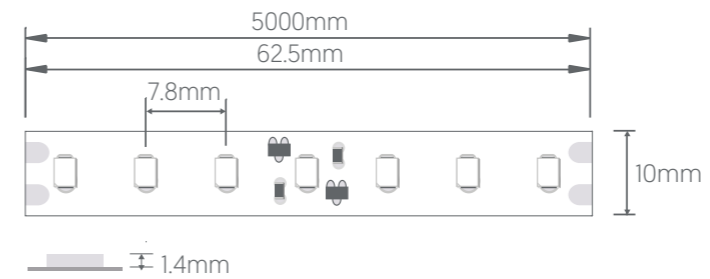

LIGHT DISTRIBUTION

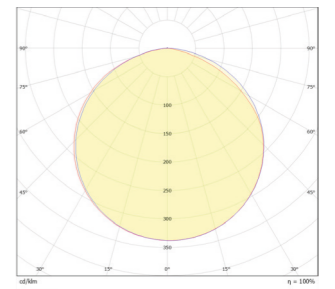

ACCESORIES

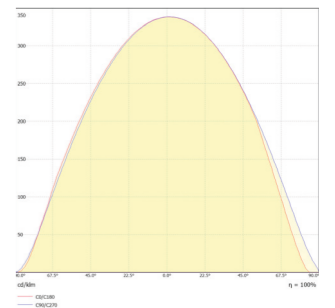
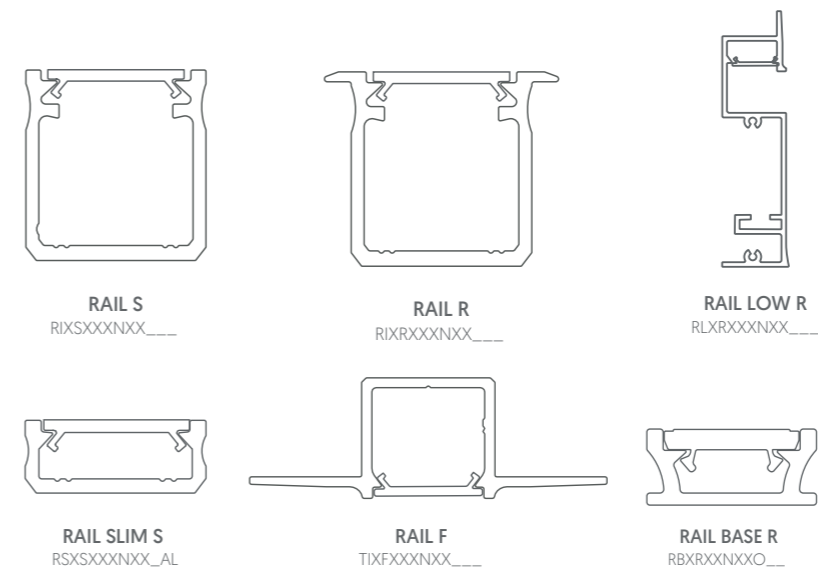

4.8W IP65

Qualities



Led Colour



Regulation



Beam Angle



High efficiency constant current circuit design to realize 160lm/w led strip achieving real green, energy saving and environmental protection. The High Efficiency SMD2835 LED strip light product line is an ideal solution for commercial applications needing maximum brightness to highlight features.

TECHNICAL DATA

	CODE	W	VOLTAGE	TEMP	LUM/m	CRI	PUBLIC PRICE / meter
Tira LED 4.8W IP65	TL05A05N29X60			2.700K			14.30 €
	TL05A05N39X60	4.8	24V	3.000K	>760lm	>90	14.30 €
	TL05A05N49X60			4.000K			14.30 €

TEC. DRAWINGS

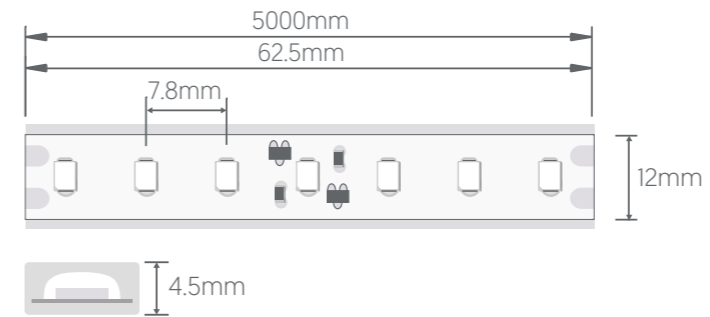

LIGHT DISTRIBUTION

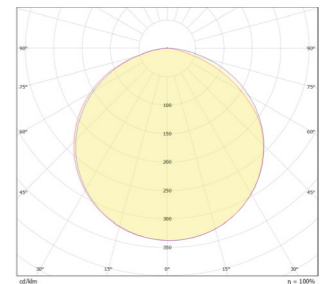

ACCESORIES

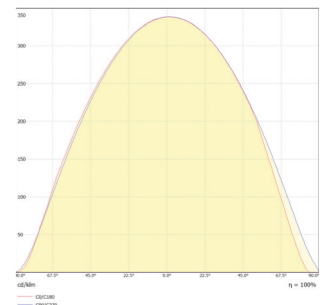
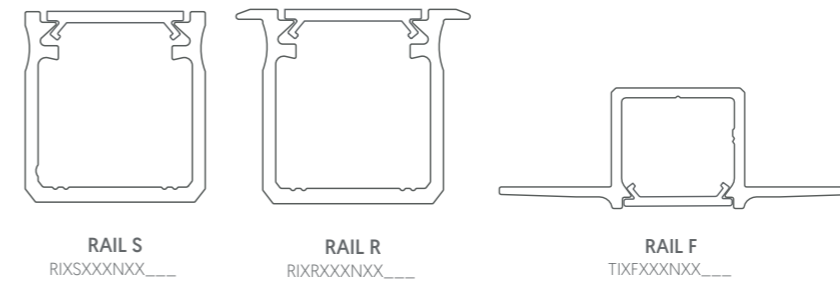

14.4W

Qualities



Led Colour

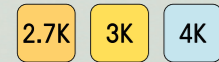

Regulation



Beam Angle



High efficiency constant current circuit. The High Efficiency SMD2835 LED strip light product line is an ideal solution for advertising, decoration and other scenes needing maximum brightness to highlight features.

TECHNICAL DATA

	CODE	W	VOLTAGE	TEMP	LUM/m	CRI	PUBLIC PRICE / meter
Tira LED 14.4W	TL14A14N29X20			2.700K	1416lm		11.89 €
	TL14A14N39X20	14.4	24V	3.000K	1522lm	>90	11.89 €
	TL14A14N49X20			4.000K	1580lm		11.89 €

TEC. DRAWINGS

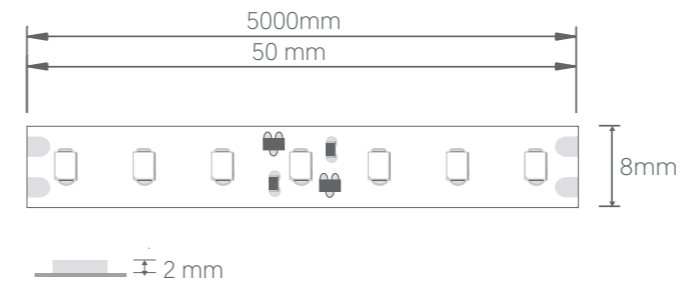

LIGHT DISTRIBUTION

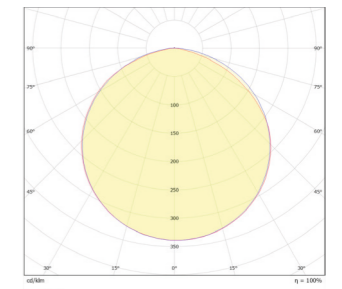

ACCESORIES

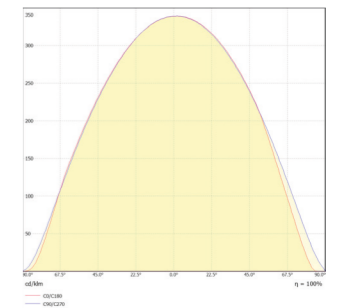
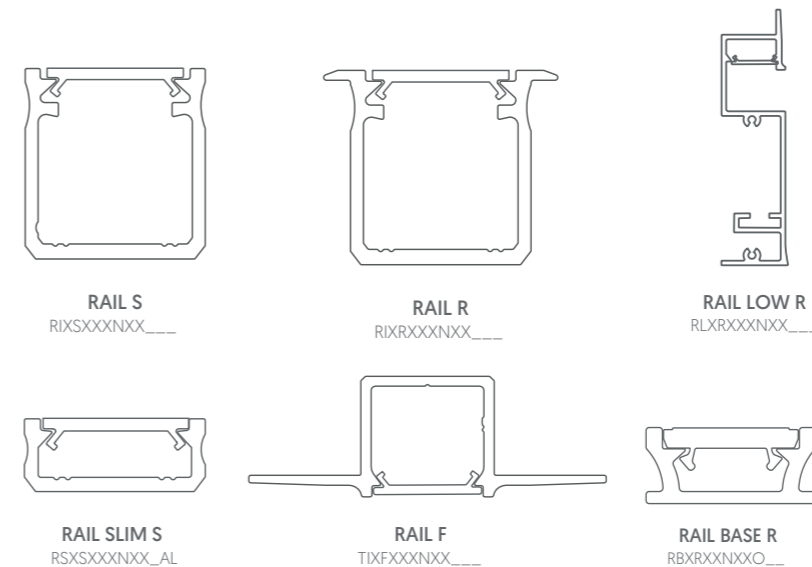

14.4W IP65

Qualities



Led Colour



Regulation



Beam Angle



High efficiency constant current circuit. The High Efficiency SMD2835 LED strip light product line is an ideal solution for advertising, decoration and other scenes needing maximum brightness to highlight features.

TECHNICAL DATA

	CODE	W	VOLTAGE	TEMP	LUM/m	CRI	PUBLIC PRICE / meter
Tira LED 14.4W IP65	TL14A14N29X60			2.700K	1416lm		13.61 €
	TL14A14N39X60	14.4	24V	3.000K	1522lm	>90	13.61 €
	TL14A14N49X60			4.000K	1580lm		13.61 €



TEC. DRAWINGS

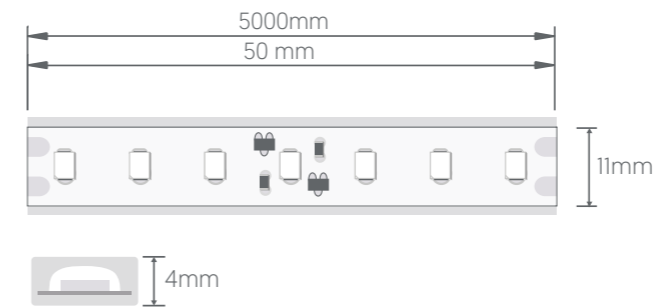

LIGHT DISTRIBUTION

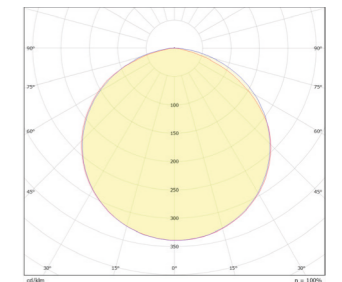

ACCESORIES

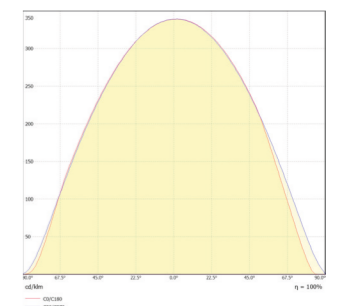
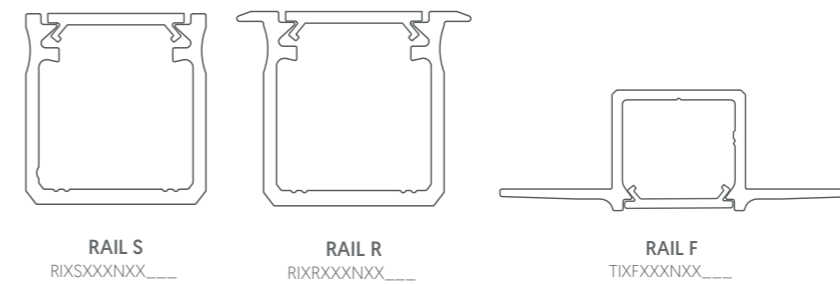

18W

Qualities

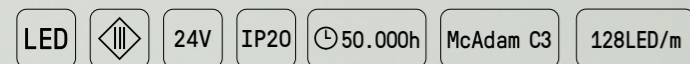

Led Colour

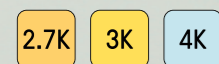

Regulation



Beam Angle

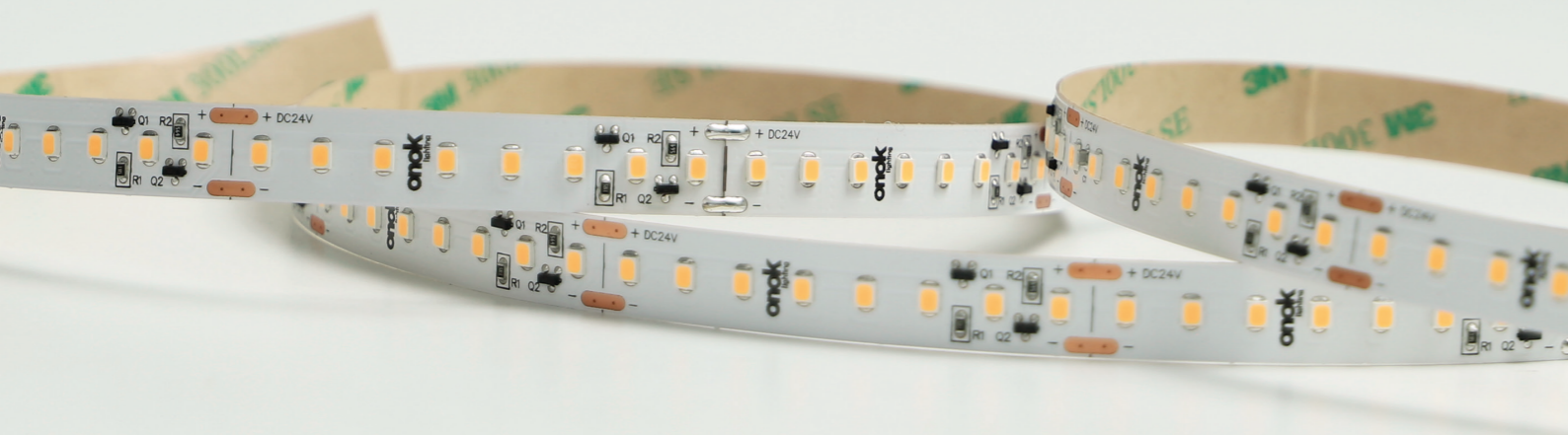

High efficiency constant current circuit design to realize 160lm/w led strip achieving real green, energy saving and environmental protection. The High Efficiency SMD2835 LED strip light product line is an ideal solution for commercial applications needing maximum brightness to highlight features.

TECHNICAL DATA

	CODE	W	VOLTAGE	TEMP	LUM/m	CRI	PUBLIC PRICE / meter
Tira LED 18W	TL18A18N29X20	18	24V	2.700K	2890lm	>90	15.47 €
	TL18A18N39X20			3.000K	2934lm		15.47 €
	TL18A18N49X20			4.000K	3034lm		15.47 €

TEC. DRAWINGS

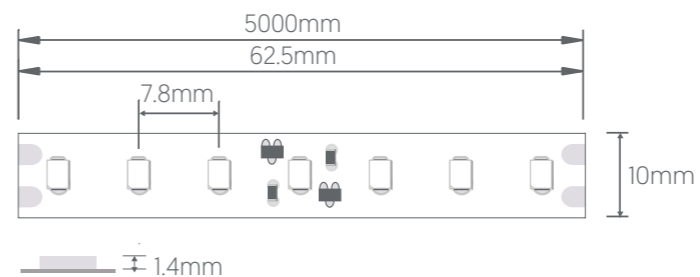

LIGHT DISTRIBUTION

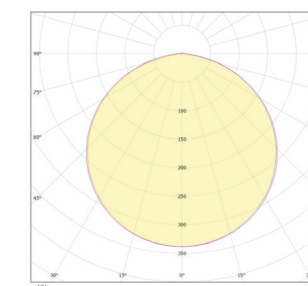

ACCESORIES

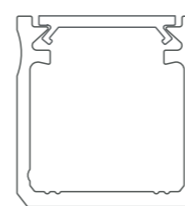

RAIL S
RIXSXXXNXX_

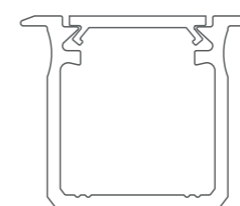

RAIL R
RIXRXXXNXX_



RAIL SLIM S
RSXXXXNXX_AL



RAIL F
TIXFXXXNXX_

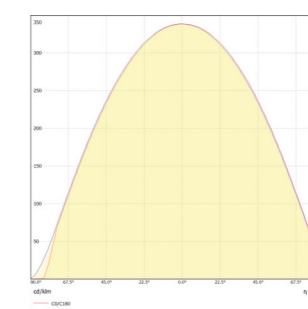

tunable white

tw

28.8W TW

Qualities



Led Colour



Regulation



Beam Angle



This CCT 3014 LED strips is characterized by a different color temperature can be arbitrarily adjusted in order to achieve the environment warm and cold tones of the different needs, to meet different lighting effects. This will not only widely expand the usage of the product, but also cut your cost, enabling stable performance and long term use.

TECHNICAL DATA

	CODE	W	VOLTAGE	TEMP	LUM/m	CRI	PUBLIC PRICE / meter
Tira LED 28.8W	TLTWA23N89X20	28.8	24V	TW	>1043	>90	15.47 €

TEC. DRAWINGS

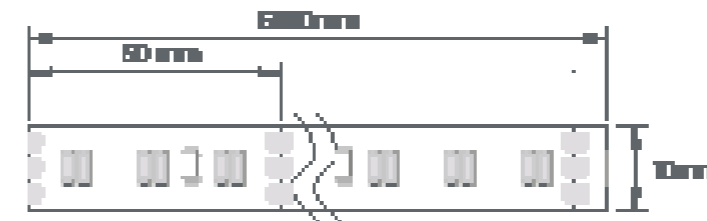

LIGHT DISTRIBUTION

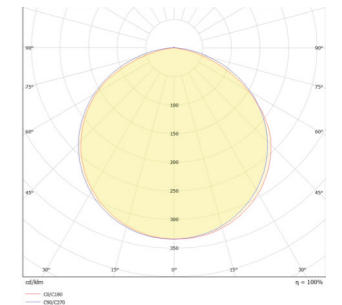

ACCESORIES

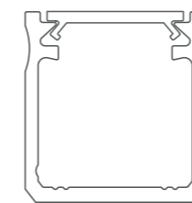

RAIL S
RIXXXXXXXX_

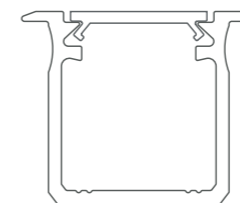

RAIL R
RIXXXXXXXX_



RAIL LOW R
RLXXXXXXX_



RAIL SLIM S
RSXXXXXXX_AL

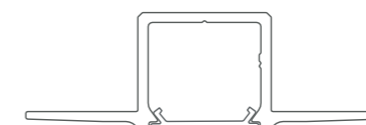

RAIL F
TIXXXXXXXX_



RAIL BASE R
RBXXXXXXO_

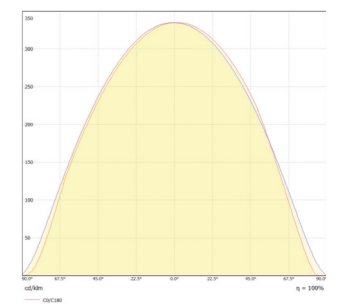

rgb

rgb

14.4W RGB

Qualities



Led Colour



Regulation



Beam Angle



DC24V power supply, safety and energy saving, high brightness 2835RGB LED High density, RGB color led strip, more wide the use environment.

TECHNICAL DATA

	CODE	W	VOLTAGE	TEMP	LUM/m	CRI	PUBLIC PRICE / meter
Tira LED 14.4W	TRGBA09N79X20	14.4	24V	RGB	>450lm	-	14.96 €

TEC. DRAWINGS

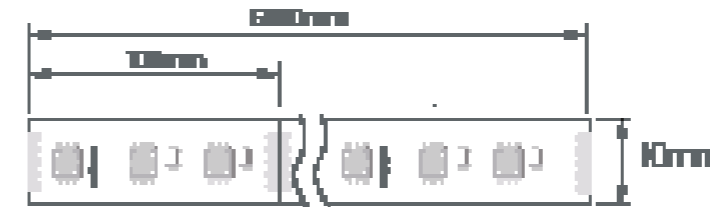

LIGHT DISTRIBUTION

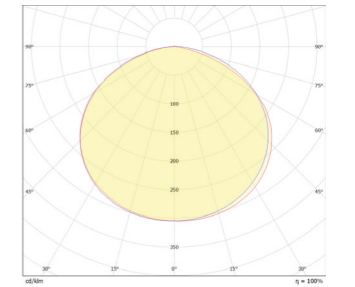

ACCESORIES

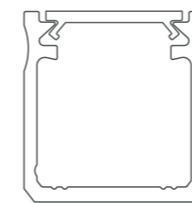

RAIL S
RIXSXXXNXX_

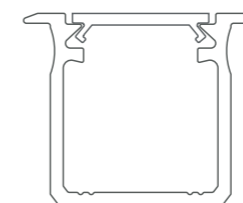

RAIL R
RIXRXXXNXX_



RAIL LOW R
RLXRXXXNXX_



RAIL SLIM S
RSXXXXNXX_AL



RAIL F
TIXFXXXNXX_



RAIL BASE R
RBXRXXXNXXO_

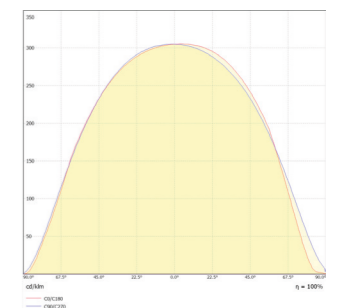

19W RGBW

Qualities



Led Colour



Regulation



Beam Angle



RGBW 4 chips in 1 LED strip allows for freely choosing RGB colors, warm white, white, and any RGBW mixed colors using RGBW controllers. One type of RGBW LED strip is equivalent to several types of common LED strips.

TECHNICAL DATA

	CODE	W	VOLTAGE	TEMP	LUM/m	CRI	PUBLIC PRICE / meter
Tira LED 19W	TLRWA19N99X20	19	24V	RGBW [3K]	>850lm	>90	14.45 €

TEC. DRAWINGS

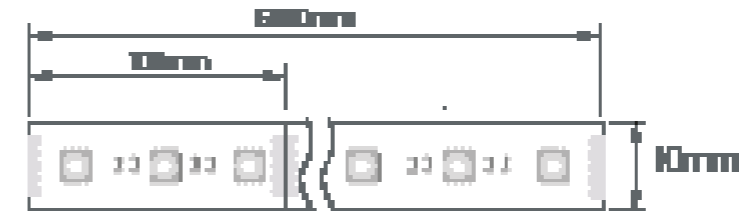

LIGHT DISTRIBUTION

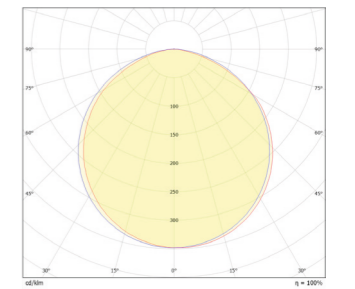

ACCESORIES

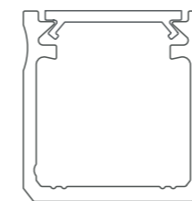

RAIL S
RIXSXXXNXX_

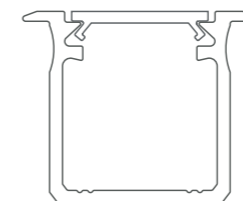

RAIL R
RIXRXXXNXX_



RAIL LOW R
RLXRXXXNXX_

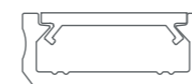

RAIL SLIM S
RSXSXXXNXX_AL



RAIL F
TIXFXXXNXX_



RAIL BASE R
RBXRXXXNXXO_

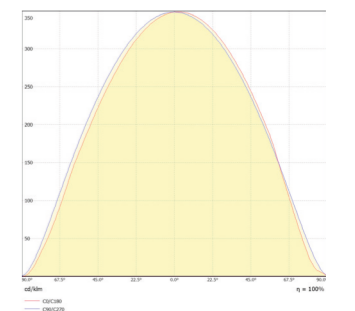

14.4W DIGITAL

Qualities



Led Colour



Regulation



Beam Angle



Compatible with DMX512 [1990] protocol. Adopting RS485 signal trunk and signal differential transmission mode to ensure stronger ability of anti-interference and longer transmission distance. Automatically addressing with editor

TECHNICAL DATA

	CODE	W	VOLTAGE	TEMP	LUM/m	CRI	PUBLIC PRICE / meter
Tira LED 14.4W	TLDTA14N99X20	14.4	24V	RGBW [3K]	718lm	>90	27.22 €

TEC. DRAWINGS



LIGHT DISTRIBUTION

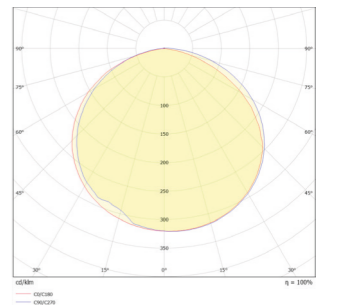

ACCESORIES

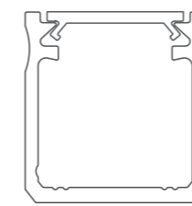

RAIL S
RIXXXXXXXX_

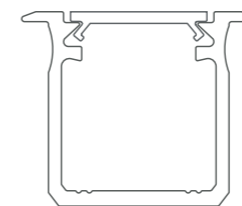

RAIL R
RIXXXXXXXX_



RAIL LOW R
RLXXXXXXX_



RAIL SLIM S
RSXXXXXXX_AL



RAIL F
TIXXXXXXXX_



RAIL BASE R
RBXXXXXXO_

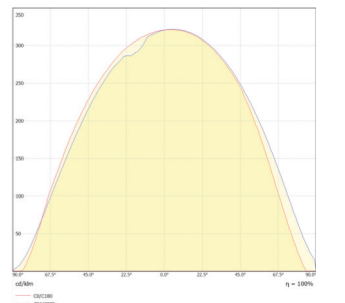

cob

cob

7W

Qualities



Led Colour

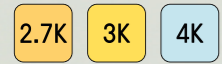

Regulation



Beam Angle



No spot, no shadow, soft light. The antistatic grade (MIL - STD - 883 - e); HBM level 2 (2000 ~ 4000 v). The largest emitting angle can reach to 180°. Can be cut, and be free to cut off and weld along with the above cutting line.

TECHNICAL DATA

	CODE	W	VOLTAGE	TEMP	LUM/m	CRI	PUBLIC PRICE / meter
	TL07A07N29X20			2.700K	420lm		8.15 €
Tira LED 7W	TL07A07N39X20	7	24V	3.000K	448lm	>90	8.15 €
	TL07A07N49X20			4.000K	504lm		8.15 €

TEC. DRAWINGS

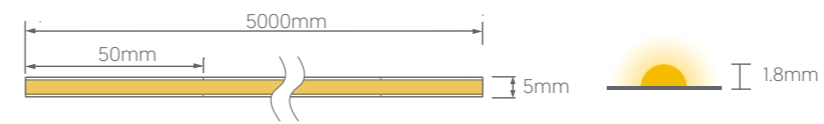

LIGHT DISTRIBUTION

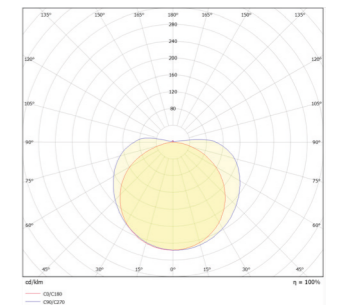

ACCESORIES



RAIL SLIM S
RSXSXXXNXX_AL



RAIL MICRO S
RMSXSXXXNXX_

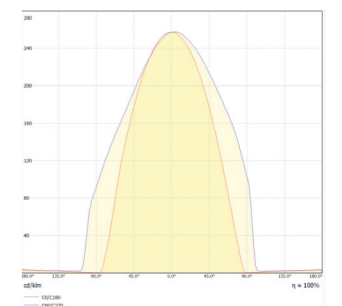

10W

Qualities



Led Colour

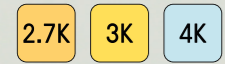

Regulation



Beam Angle



No spot, no shadow, soft light. The antistatic grade (MIL - STD - 883 - e) : HBM level 2 [2000 ~ 4000 v]. The largest emitting angle can reach to 180°.

TECHNICAL DATA

	CODE	W	VOLTAGE	TEMP	LUM/m	CRI	PUBLIC PRICE / meter
Tira LED 10W	TL10A10N29X20	10	24V	2.700K	830lm	>90	8.34 €
	TL10A10N39X20			3.000K	960lm		8.34 €
	TL10A10N49X20			4.000K	1000lm		8.34 €

TEC. DRAWINGS

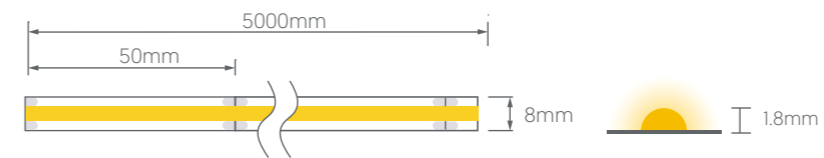

LIGHT DISTRIBUTION

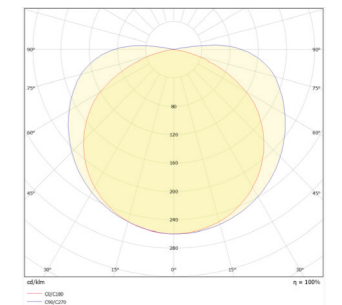

ACCESORIES



RAIL SLIM S
RSXSXXXNXX_AL



RAIL MICRO S
RMSXSXXXNXX_---

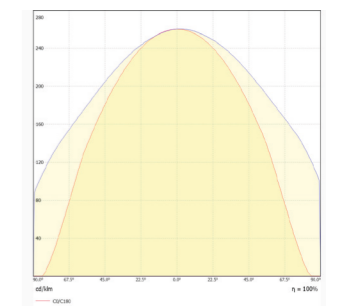

neon

neón

10W 06x12

Qualities



Led Colour

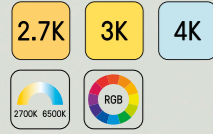

Regulation



Beam Angle



IP67 FLEX LED NEON, DC24V. Cross section size 6mm x 12mm[W x H], which is horizontal bending with diameter of 50mm. It is IP67 protected, UV resistant, solvents resistant and saltwater resistant. Dot free will bring the most excellent performance for indoor & outdoor applications.

TECHNICAL DATA

	CODE	W	VOLTAGE	TEMP	LUM/m	CRI	PUBLIC PRICE / meter
Tira Neón 06x12 10W	TN01A10N29X67			2.700K	350lm		17.30 €
	TN01A10N39X67			3.000K	300lm		17.30 €
	TN01A10N49X67	10	24V	4.000K	360lm	>90	17.30 €
	TN01A10N89X67			TW	270lm		26.93 €
	TN01A10N79X67			RGB	130lm		22.54 €
Mounting Clip	CN01XXXXXXXSS	-	-	-	-	-	0.41€

TEC. DRAWINGS

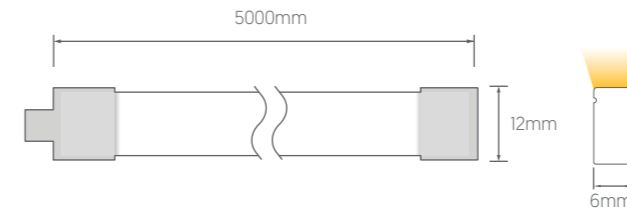

LIGHT DISTRIBUTION

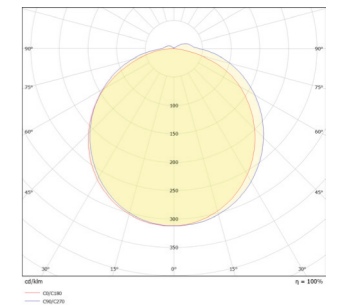

ACCESORIES



MOUNTING CLIP
CN01XXXXXXXSS

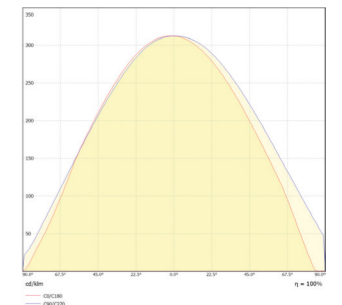

10W 10x10

Qualities



Led Colour



Regulation



Beam Angle



IP67 FLEX LED NEON, DC24V. Cross section size 10mm x 10mm[W x H], which is vertical bending with diameter of 100mm. It is IP67 protected, UV resistant, solvents resistant and saltwater resistant. Dot free will bring the most excellent performance for indoor & outdoor applications.

TECHNICAL DATA

	CODE	W	VOLTAGE	TEMP	LUM/m	CRI	PUBLIC PRICE / meter
Tira Neón 10x10 10W	TN02A10N29X67	10	24V	2.700K	570lm	>90	19.17 €
	TN02A10N39X67			3.000K	620lm		19.17 €
	TN02A10N49X67			4.000K	660lm		19.17 €
Mounting Clip	CN02XXXXXXXXSS	-	-	-	-	-	0.41€
	CN02XXXXXXXXAL	-	-	-	-	-	0.73€

TEC. DRAWINGS

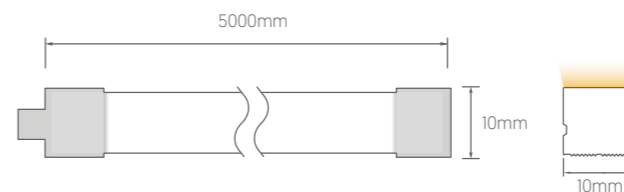

LIGHT DISTRIBUTION

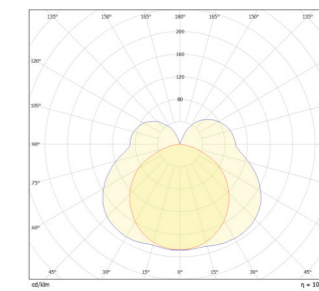

ACCESORIES



MOUNTING CLIP
CN02XXXXXXXXSS

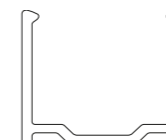

MOUNTING CLIP
CN02XXXXXXXXAL

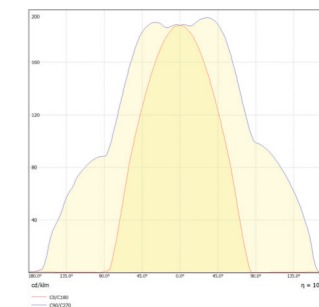

profiles

perfiles

Rail S

Qualities



Diffuser

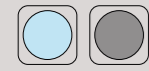

Finish



Installation



RAIL S aluminium profile for surface-mounting. Perfect for household and office room illumination - lighting of columns, countertops. This is an innovative product on the lighting market. One of the most minimalist and modern designs. The extremely interesting and modern design of the RAIL S profile allows us to meet the needs of our customers in the use of LED strips for the creation of light lines.

TECHNICAL DATA

	CODE	PROFILE FINISH	DIFFUSER	PUBLIC PRICE / meter
Rail S	RIXSXXXNXXAAL	Aluminium	Ice	21.26 €
	RIXSXXXNXXABS	Satin Black	Ice	22.92 €
	RIXSXXXNXXAWS	Satin White	Ice	22.07 €
	RIXSXXXNXXNAL	Aluminium	Black	22.49 €
	RIXSXXXNXXNBS	Satin Black	Black	24.14 €
	RIXSXXXNXXNWS	Satin White	Black	23.29€
End Caps	TPXSX_XXXXXPL	Silver	-	0.33 €
	TPXSX_XXXXXBX	Black	-	0.33 €
	TPXSX_XXXXXWX	White	-	0.33 €

DIFUSSERS

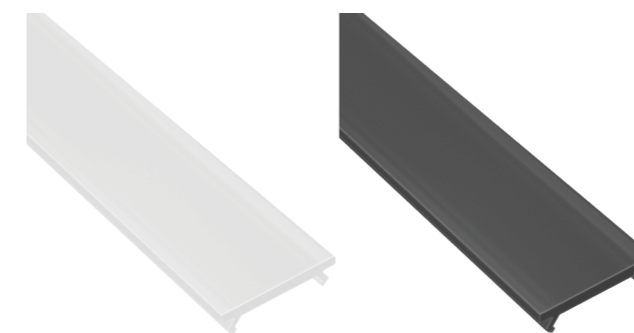

TEC. DRAWINGS

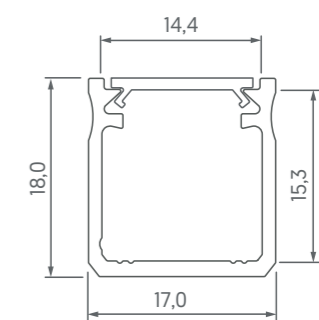

END CAPS

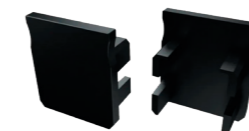

Rail R

Qualities



Diffuser

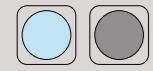

Finish



Installation



RAIL R is a groove mounted profile – for lighting kitchens and stores. Ideal for lighting shelves, countertops and stairs.

TECHNICAL DATA

	CODE	PROFILE FINISH	DIFFUSER	PUBLIC PRICE / meter
Rail R	RIXRXXNXXAAL	Aluminium	Ice	20.38 €
	RIXRXXNXXABS	Satin Black	Ice	22.62 €
	RIXRXXNXXAWS	Satin White	Ice	21.65 €
	RIXRXXNXXNAL	Aluminium	Black	21.60 €
	RIXRXXNXXNBS	Satin Black	Black	23.84 €
	RIXRXXNXXNWS	Satin White	Black	22.87 €
End Caps	TPXRPXXXXXPL	Silver	-	0.33 €
	TPXRPXXXXXBX	Black	-	0.33 €
	TPXRPXXXXXWX	White	-	0.33 €

DIFUSSERS

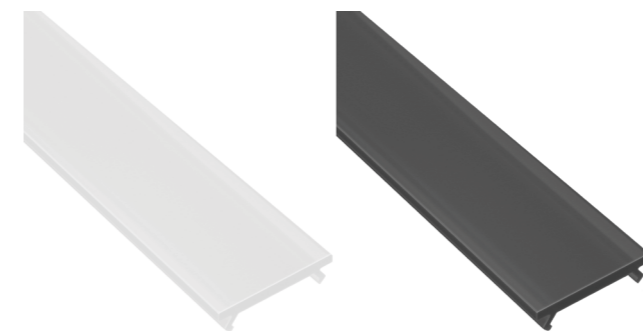

TEC. DRAWINGS

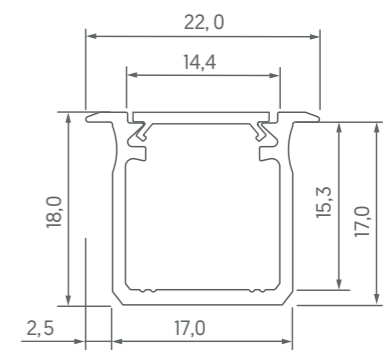

END CAPS



Rail F

Qualities



Diffuser

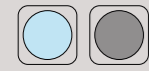

Finish



Installation



LED profile for installation and finishing with plaster, designed for one LED strip installation. Thanks to its simplified design, it enables quick and easy installation.

TECHNICAL DATA

	CODE	PROFILE FINISH	DIFFUSER	PUBLIC PRICE / meter
Rail F	RIXFXXXNXXNBS	Satin Black	Black	26.94 €
	RIXFXXXNXXNWS	Satin White	Black	26.94 €
	RIXFXXXNXXABS	Satin Black	Ice	25.72 €
	RIXFXXXNXXAWS	Satin White	Ice	25.72 €
End Caps	TPXFXPXXXXXB	Black	-	0.77 €
	TPXFXPXXXXWX	White	-	0.77 €

DIFUSSERS

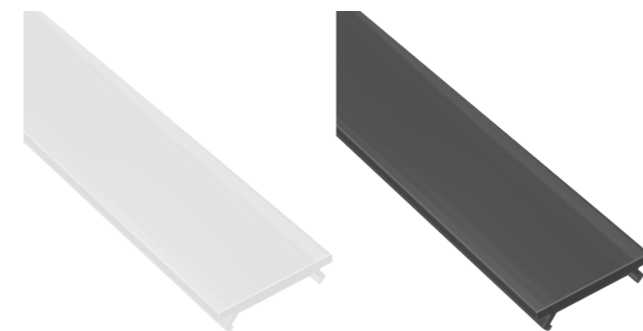

TEC. DRAWINGS

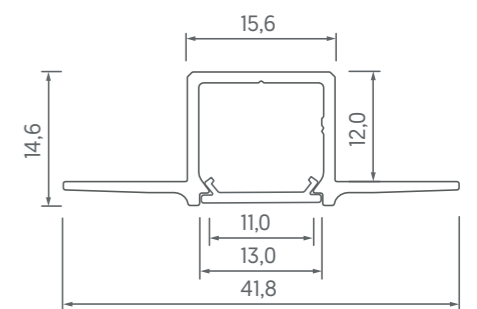

END CAPS



Rail Base R

Qualities



Diffuser



Finish



Installation



RAIL BASE R is a groove mounted profile designed for use on the floor. Thanks to the sealing glass shade of the anti-moisture, LED strips can also be used in areas exposed to the appearance of moisture.

TECHNICAL DATA

	CODE	PROFILE FINISH	DIFFUSER	PUBLIC PRICE / meter
Rail Base R	RBXRXNXXOAL	Aluminium	Opal	25.71 €
	RBXRXNXXOBS	Satin Black	Opal	27.87 €
	RBXRXNXXOWS	Satin White	Opal	27.86 €
End Caps	TPBRX_XXXXXPL	Silver	-	0.49 €
	TPBRX_XXXXXBX	Black	-	0.49 €
	TPBRX_XXXXXWX	White	-	0.49 €

DIFUSSERS

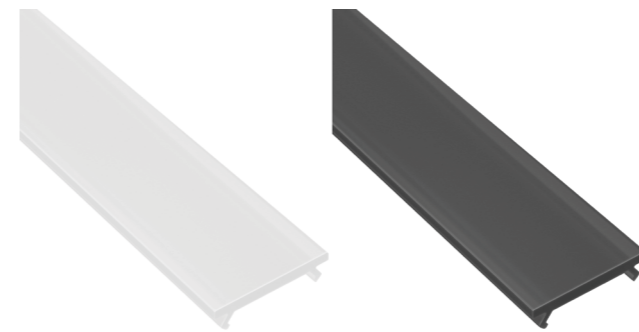

TEC. DRAWINGS

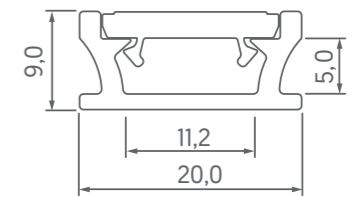

END CAPS



Rail Low R

Qualities



Diffuser

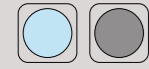

Finish



Installation



RAIL LOW R is an indoor skirting profile. Designed for lighting residential compartments and commercial facilities.

TECHNICAL DATA

	CODE	PROFILE FINISH	DIFFUSER	PUBLIC PRICE / meter
Rail Low R	RLXRXNXXAAL	Aluminium	Ice	43.86 €
	RLXRXNXXABS	Satin Black	Ice	45.47 €
	RLXRXNXXAWS	Satin White	Ice	45.47 €
	RLXRXNXXNAL	Aluminium	Black	45.09 €
	RLXRXNXXNBS	Satin Black	Black	46.69 €
	RLXRXNXXNWS	Satin White	Black	46.69 €
End Caps	TPLRX_XXXX_PL	Silver	-	10.53 €
	TPLRX_XXXX_BX	Black	-	10.53 €
	TPLRX_XXXX_WX	White	-	10.53 €

DIFUSSERS

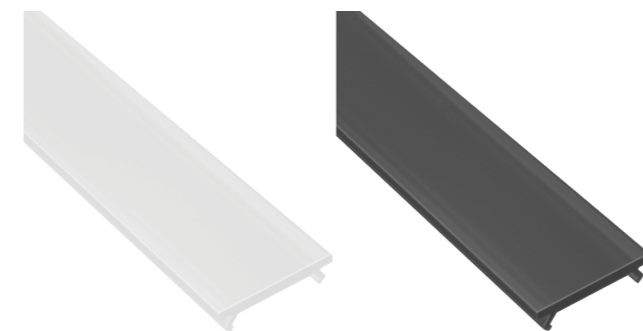

END CAPS



TEC. DRAWINGS

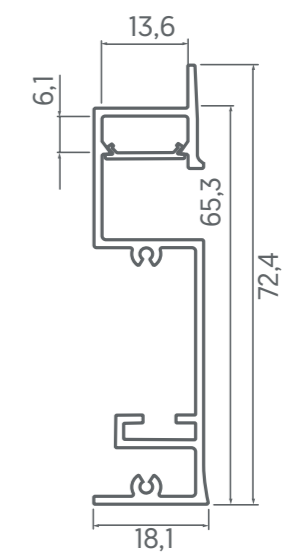

Rail Micro S

Qualities



Diffuser

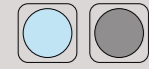

Finish



Installation



RAIL MICRO S aluminium profile is a surface-mounted profile with minimalist dimensions, designed for simple and fast installation in hard-to-reach places. It is ideal for discrete lighting in kitchens, stores and lighting countertops, handrails. RAIL MICRO S is perfectly suited for decorative backlighting in furniture and interior decorations.

TECHNICAL DATA

	CODE	PROFILE FINISH	DIFFUSER	PUBLIC PRICE / meter
Rail Micro S	RMXSXXXNXXAAL	Aluminium	Ice	14.95 €
	RMXSXXXNXXABS	Satin Black	Ice	15.64 €
	RMXSXXXNXXAWS	Satin White	Ice	15.23 €
	RMXSXXXNXXNAL	Aluminium	Black	16.17 €
	RMXSXXXNXXNBS	Satin Black	Black	16.86 €
	RMXSXXXNXXNWS	Satin White	Black	16.45 €
End Caps	TPMSX_XXXXXPL	Silver	-	0.33 €
	TPMSX_XXXXXBX	Black	-	0.33 €
	TPMSX_XXXXXWX	White	-	0.33 €

DIFUSSERS

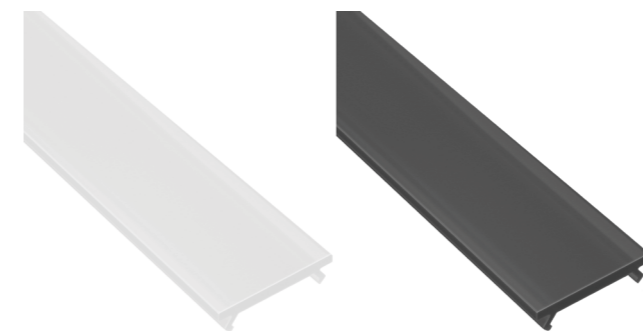

TEC. DRAWINGS

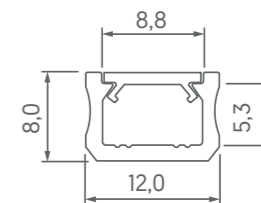

END CAPS

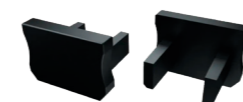

Rail Slim S

Qualities



Diffuser

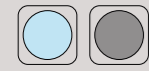

Finish



Installation



RAIL SLIM S is a surface-mounted profile - for lighting kitchens and stores. Ideal for lighting shelves, countertops, stairs. Suitable for installation in hard-to-reach places and for the use of wide strips. One of the most minimalist and modern designs. It is a profile designed for the installation of LED strips in hard-to-reach places. Due to its dimensions, it enables us to obtain the maximum amount of light, with the minimal size of the profile.

TECHNICAL DATA

	CODE	PROFILE FINISH	DIFFUSER	PUBLIC PRICE / meter
Rail Slim S	RSXSXXXNXXAAL	Aluminium	Ice	15.26 €
	RSXSXXXNXXABS	Satin Black	Ice	16.81 €
	RSXSXXXNXXAWS	Satin White	Ice	16.30 €
	RSXSXXXNXXNAL	Aluminium	Black	16.49 €
	RSXSXXXNXXNBS	Satin Black	Black	18.03 €
	RSXSXXXNXXNWS	Satin White	Black	17.52 €
End Caps	TPSSX_XXXXXPL	Silver	-	0.33 €
	TPSSX_XXXXXBX	Black	-	0.33 €
	TPSSX_XXXXXWX	White	-	0.33 €

DIFUSSERS

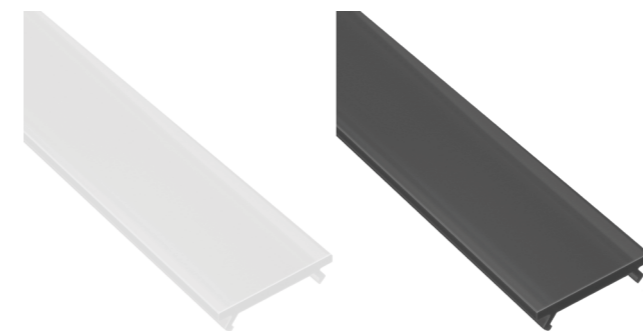

TEC. DRAWINGS

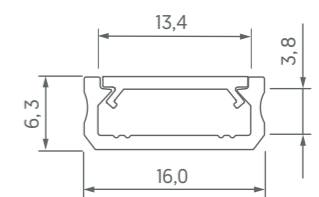

END CAPS



power supply

**fuentes de
alimentación**

IP20 POWER SUPPLY



TECHNICAL DATA

	CODE	DESCRIPTION	PUBLIC PRICE
IP20 Power Supply	CDRVT302NGAB0	24V / 30W constant voltage power supply, non-dimmable and IP20.	20.05 €
	CDRVT602NGAB1	24V / 60W constant voltage power supply, non-dimmable and IP20.	29.18 €
	CDRVT752NGAB0	24V / 75W constant voltage power supply, non-dimmable and IP20.	29.62 €
	CDRVTCD2NGAA0	24V / 150W constant voltage power supply, non-dimmable and IP20.	64.92 €

IP67 POWER SUPPLY



TECHNICAL DATA

	CODE	DESCRIPTION	PUBLIC PRICE
IP67 Power Supply	CDRVT202NGAB0	24V / 20W constant voltage power supply, non-dimmable and IP67	20.30 €
	CDRVT352NGAB0	24V / 35W constant voltage power supply, non-dimmable and IP67	35.45 €
	CDRVT602NGAB0	24V / 60W constant voltage power supply, non-dimmable and IP67	31.10 €
	CDRVT902FGAB0	24V / 90W constant voltage power supply, non-dimmable and IP67	51.40 €
	CDRVT1C2NGAB0	24V / 100W constant voltage power supply, non-dimmable and IP67	49.39 €
	CDRVTCD2NGAB0	24V / 150W constant voltage power supply, non-dimmable and IP67	71.70 €
	CDRVT1C2DGAAA	24V / 150W constant voltage power supply, dali and IP67	133.94 €

controllers

controladores

CASAMBI



Controller Max. 144W 12-24V



Controller Max. 579W 12-24-48V



Xpress Button Switch

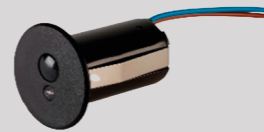

Light and Presence Sensor

TECHNICAL DATA

	CODE	DESCRIPTION	PUBLIC PRICE
	CBLUE4CONTR00	controller max. 144W 12-24V	124.16 €
	CCONTR0000004	controller max. 579W 12-24-48V	277.49 €
CASAMBI	XPREAXKXXXBS	black xpress button switch	251.14 €
	XPREAXKXXXWS	black xpress button switch	296.63 €
	SSLPXXXKXXX__	light and presence sensor black or white max. 64 lights	514.06€

BLU2LIGHT DALI

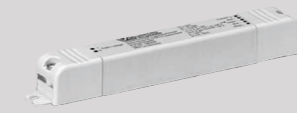

Controller Max. 115W 24-48V



Node Connect Me



Light and Presence Sensor



S4 Button Switch

TECHNICAL DATA

	CODE	DESCRIPTION	PUBLIC PRICE
	CTINY00000031	controller max. 115W 24-48V	161.82 €
	NCMEX15DXXXWS	node connect me max. 15 lights	204.32 €
	NCMEX40DXXXWS	node connect me max. 40 lights	290.01 €
	NCMEX64DXXXWS	node connect me max. 64 lights	396.40 €
CASAMBI	SSLPX15DXXX__	light and presence sensor black or white + power supply max. 15 lights	348.88 €
	SSLPX40DXXX__	light and presence sensor black or white + power supply max. 40 lights	434.58 €
	SSLPX64DXXX__	light and presence sensor black or white + power supply max. 64 lights	540.97 €
	CBLUE00000005	S4 button switch	256.58 €

